

# AIROL® Mist Eliminators for Pulp and Paper Industry



Providing both clean air & water



For horizontal flow annular installation with mist eliminator panels located on either side of the vapor outlet.

The **AIROL® 430H125** chevron mist eliminator as seen from its outlet side showing the upper bay of a two-level design.



The **AIROL® 430H125** chevron mist eliminator as seen from the inlet side showing the intermediate drain box piping, and removable retaining frames for access to chevron vane packs.





Four horizontal flow **AIROL® 430H125** panels with weld flanges and drain pipe/seal pots. these panels are commonly used for retrofit applications within the cyclonic swirl vapor heads of older evaporators.

**AIROL® 430H125** panels can be provided with bolted face frames in order to remove individual chevron sections - as well as for installation of units that otherwise would not pass through manway.

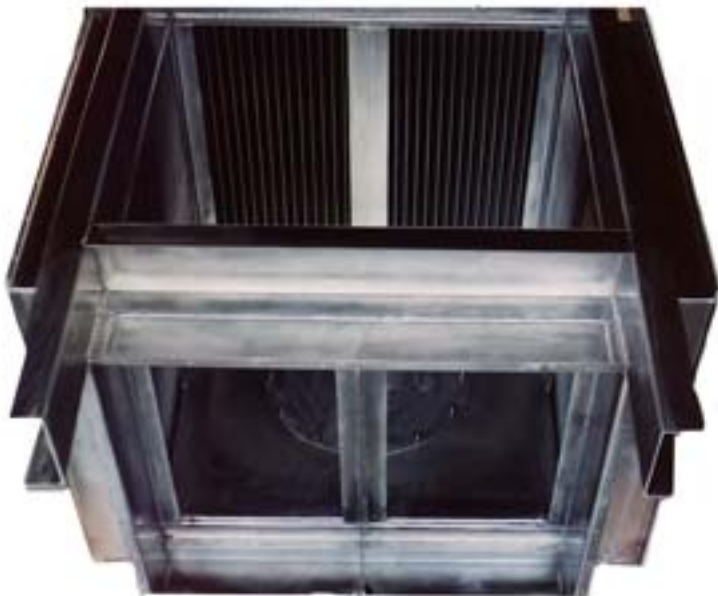

A four-panel **AIROL® 430H125** mist eliminator (with one of the four panels removed) with support beams for installation in vapor head. Note access opening in the bottom floor plate.



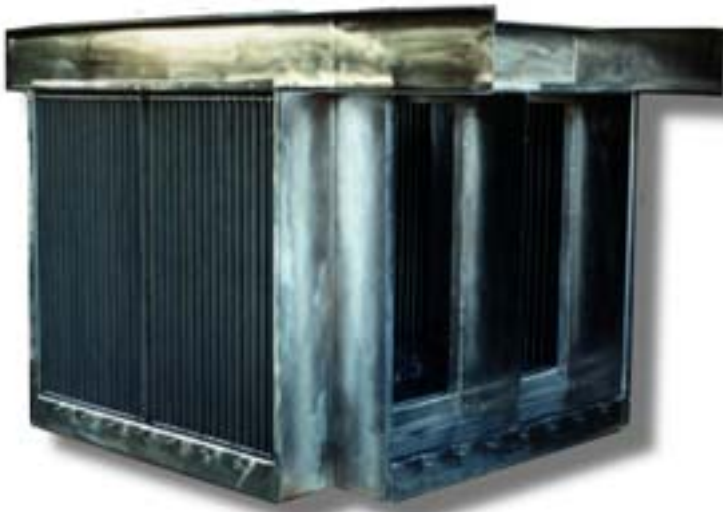

**4-PANEL HORIZONTAL FLOW  
MIST ELIMINATOR**

**AIROL® 430H125**

Performance: 10-20 ppm

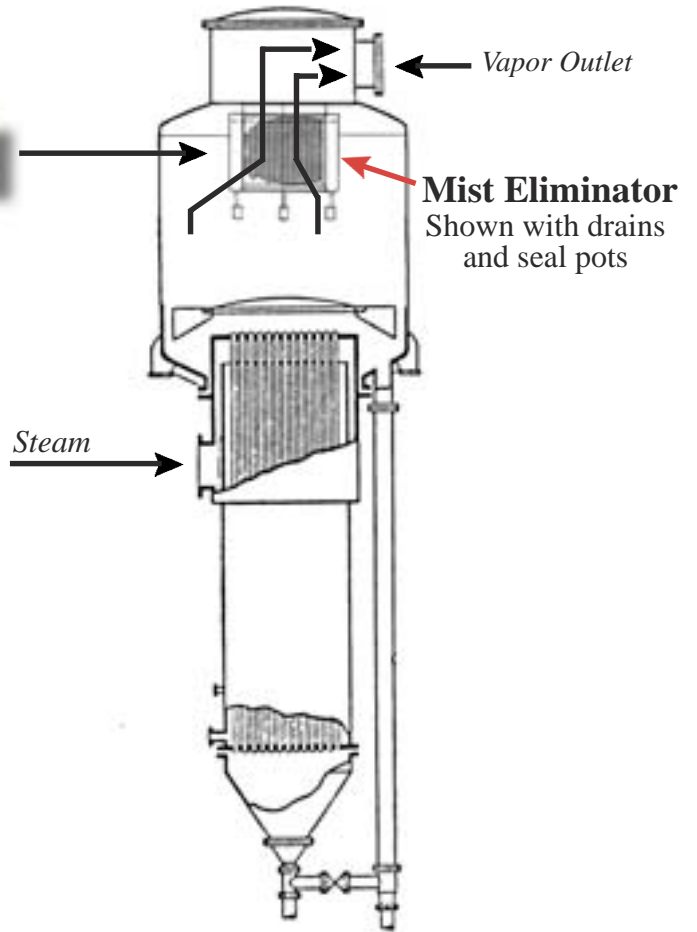

Rising Film Evaporator

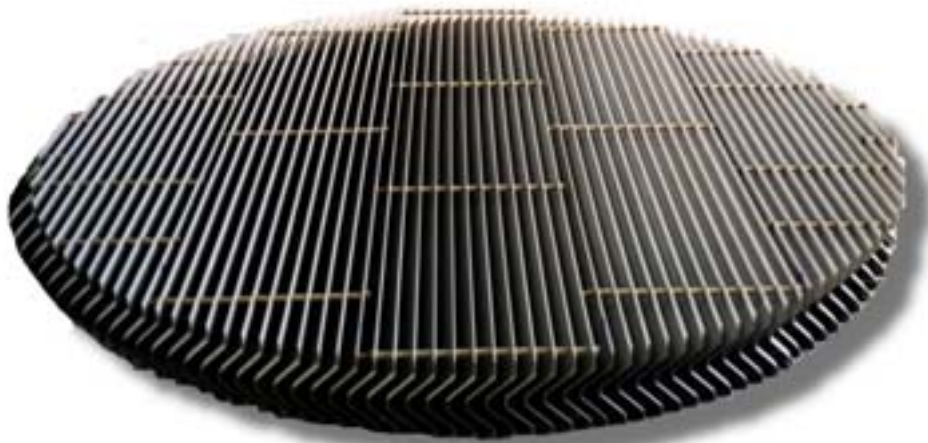

**VERTICAL FLOW MIST ELIMINATOR**

**AIROL® 120H875**

Performance: 20-30 ppm

*(ALTERNATE)*

**AIROL® 130H150**

Performance: 30-40 ppm

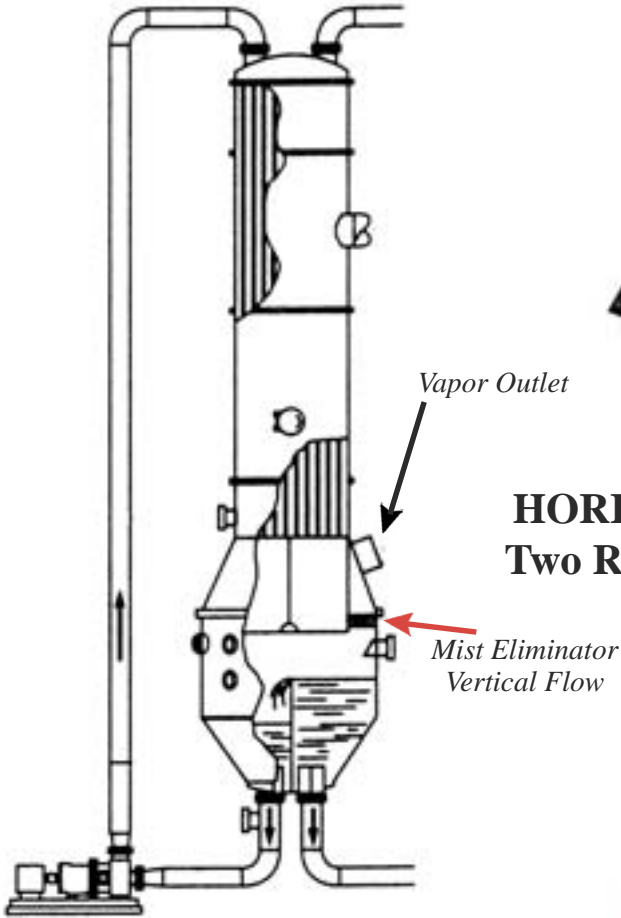

Falling Film Evaporator



**HORIZONTAL FLOW MIST ELIMINATOR**  
**Two Required; one on each side of vapor outlet**

**AIROL® 430H125**

Performance: 10-20 ppm

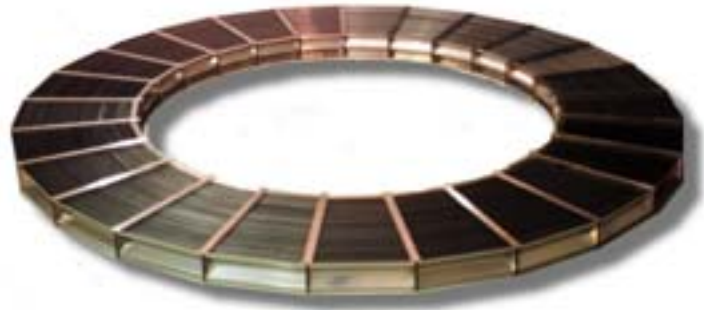

**AIROL® 120H875**

Performance: 20-30 ppm



**VERTICAL FLOW**  
**MIST ELIMINATOR**

**AIROL® 130H RADIAL**

Performance: 30-40 ppm  
 (Shown)

# Pulp and Paper Services for Mist Eliminators

- Evaporators
- Concentrators
- Power Boiler Scrubbers
- Lime Kiln Scrubbers
- Bleach Plant Scrubbers
- NCG Separators
- Dissolving Tank Vents
- Pulp Dryers
- Blow Heat Vents

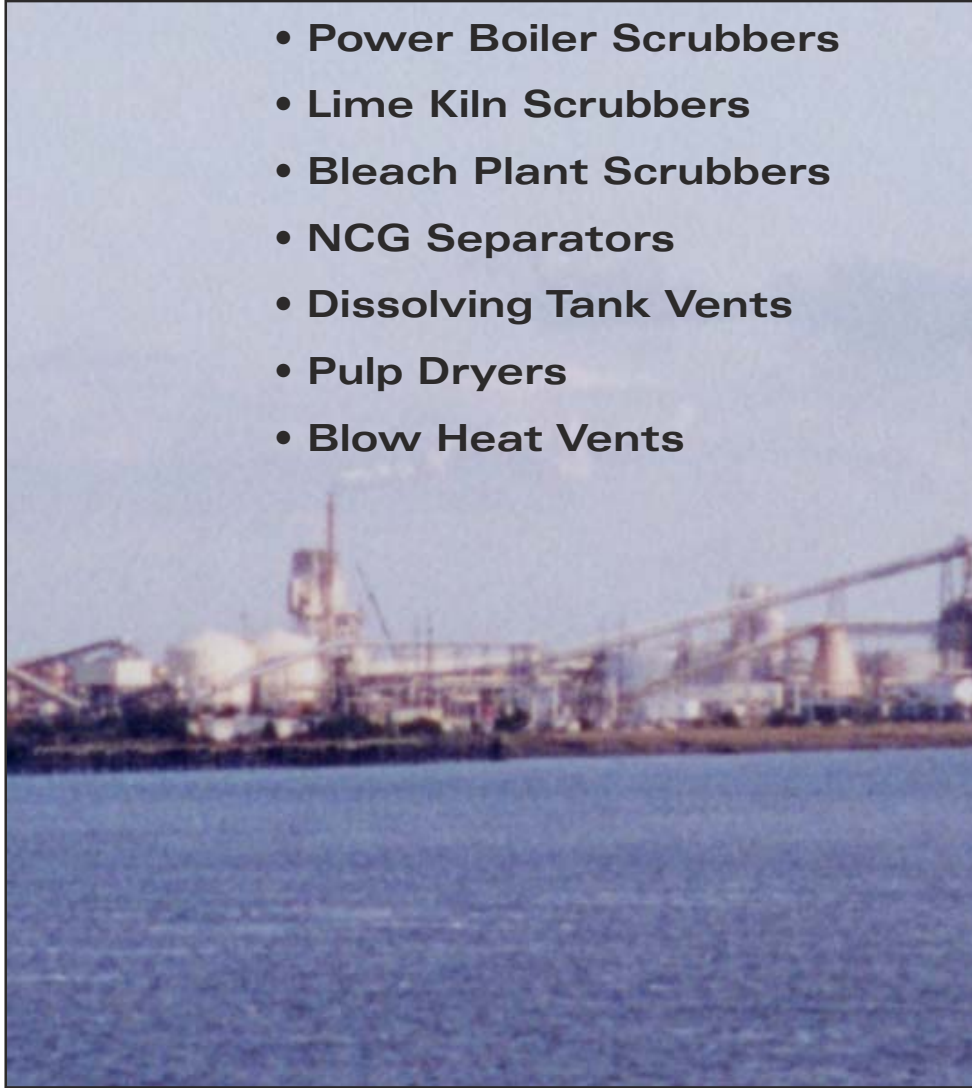

PO Box 624  
Hampton, SC 29924 USA

Phone: (803) 943-4822

Fax: (803) 943-4744

e-mail: [sales@coastaltechnologiesinc.com](mailto:sales@coastaltechnologiesinc.com)